

Specifications

Nominal Voltage		2 V
Capacity (25°C)	10HR(1.80V)	1000 Ah
	3HR(1.75V)	765Ah
	1HR(1.75V)	565Ah
Dimension	Length	475 ± 2mm (18.70inch)
	Width	175 ± 2mm (6.89inch)
	Height	330 ± 2mm (12.99inch)
	Total Height	367 ± 2mm (14.45inch)
Approx. Weight		59.5kg (131.1lbs) ± 3%
Terminal type		T10
Internal resistance (Fully charged, 25°C)		Approx. 0.28m Ω
Capacity affected by temperature (10HR)	40°C	102%
	25°C	100%
	0°C	85%
	-15°C	65%
Self-discharge (25°C)	3 month	Remaining Capacity: 91%
	6 month	Remaining Capacity: 82%
	12 month	Remaining Capacity: 65%
Nominal operating temperature		25°C ± 3°C (77°F ± 5°F)
Operating temperature range	Discharge	-15°C ~ 50°C (5°F ~ 122°F)
	Charge	-10°C ~ 50°C (14°F ~ 122°F)
	Storage	-20°C ~ 50°C (-4°F ~ 122°F)
Float charging voltage(25°C)		2.25 to 2.30V Temperature compensation: -3mV/°C
Cyclic charging voltage(25°C)		2.42 to 2.48V Temperature compensation: -5mV/°C
Maximum charging current		200A
Terminal material		Copper
Maximum discharge current		7500A(5 sec.)
Designed floating life(20°C)		20 years

- ◆ Absorbent glass mat technology;
- ◆ Recognized by UL & CE;
- ◆ ABS container.

Constant Current Discharge Characteristics (A, 25°C)

F.V/TIME	30min	60min	2h	3h	4h	5h	6h	8h	10h	20h	24h
1.60V	900	600	365	260	209	182	156	122	102	53.4	46.3
1.65V	882	591	363	259	208	180	155	122	102	53.3	46.2
1.70V	855	576	360	257	206	179	154	121	101	53.2	46.1
1.75V	834	565	355	255	205	178	153	120	101	52.9	45.8
1.80V	804	547	346	247	199	173	148	116	100	52.5	45.5

Constant Power Discharge Characteristics (Watt, 25°C)

F.V/TIME	30min	60min	2h	3h	4h	5h	6h	8h	10h	20h	24h
1.60V	1683	1140	705	510	410	358	307	244	203	107	93.1
1.65V	1649	1123	701	507	407	356	306	242	202	107	92.9
1.70V	1599	1094	695	503	405	353	304	240	202	106	92.6
1.75V	1560	1073	684	500	402	351	301	239	200	106	92.1
1.80V	1503	1040	667	485	390	340	292	232	199	105	91.5

Note: The above characteristics data can be obtained within three charge/discharge cycles.

Dimensions

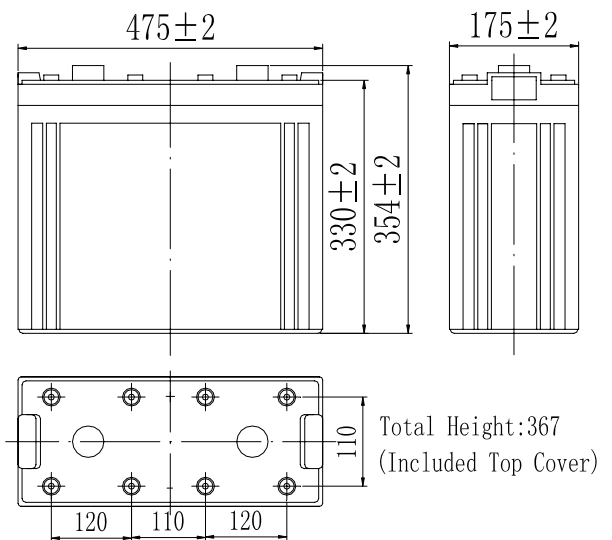

Terminal

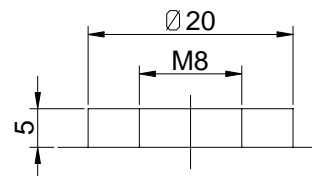

Terminal T10

Discharge Characteristics(25°C)

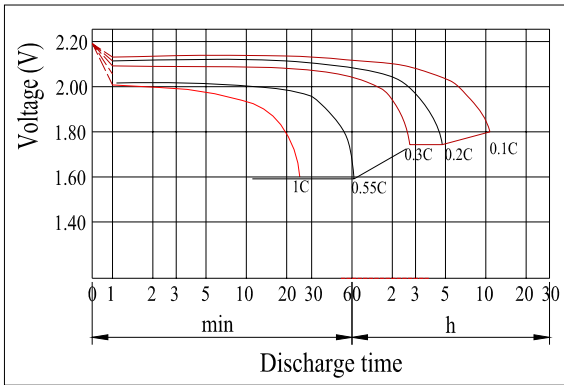

Charging Characteristics(25°C)

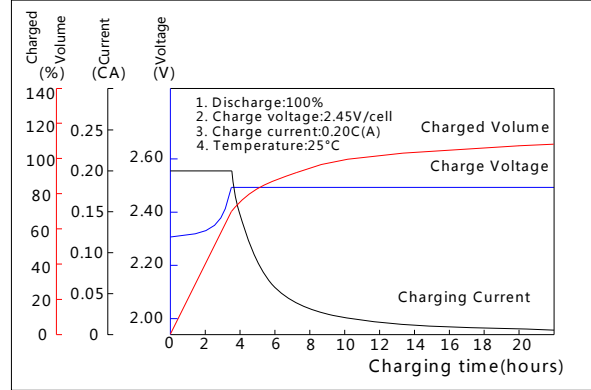

Effect of Temperature on Capacity

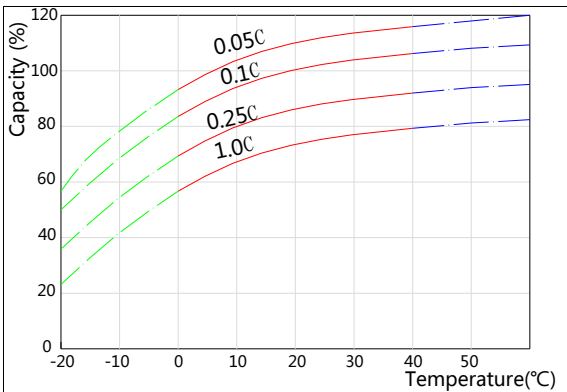

Self-discharge Characteristics

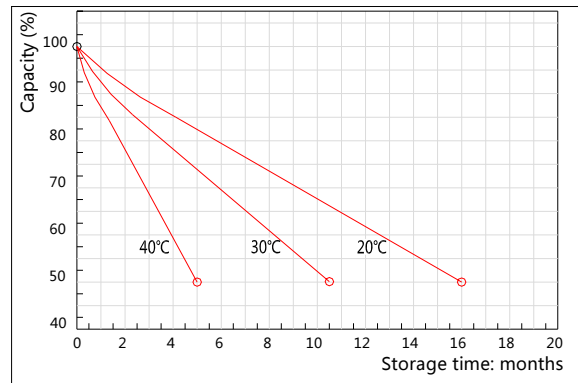

The Relationship for Open Circuit Voltage and Residual Capacity (25°C)

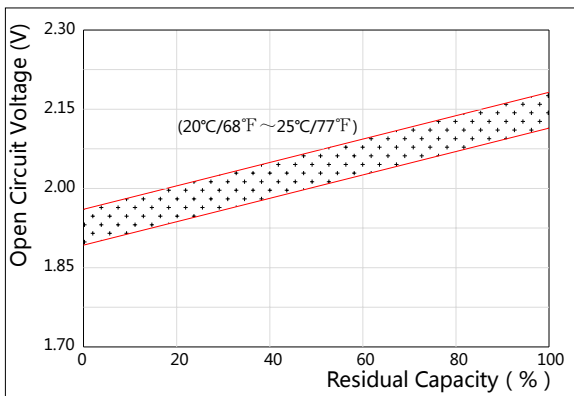

The Relationship for Charging Voltage and Temperature

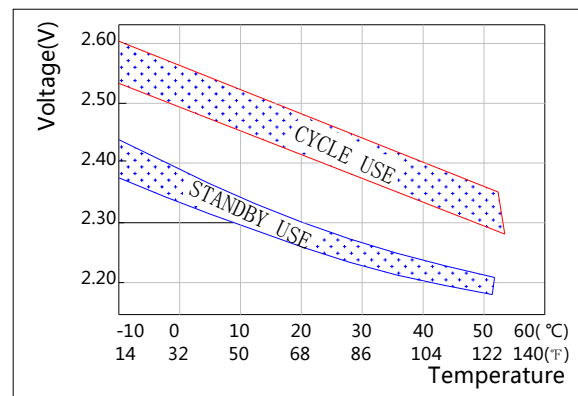

Floating Life on Temperature

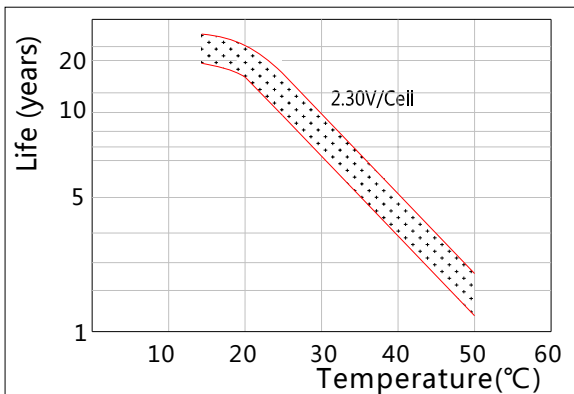

Cycle Life on D.O.D(25°C)

