

Specifications

Nominal Voltage		2 V
Capacity (25°C)	10HR(1.80V)	600 Ah
	3HR(1.75V)	459Ah
	1HR(1.75V)	339Ah
Dimension	Length	302 ± 2mm (11.89inch)
	Width	175 ± 2mm (6.89inch)
	Height	330 ± 2mm (12.99inch)
	Total Height	367 ± 2mm (14.45inch)
Approx. Weight		35kg (77.1lbs) ± 4%
Terminal type		T10
Internal resistance (Fully charged, 25°C)		Approx. 0.45m Ω
Capacity affected by temperature (10HR)	40°C	102%
	25°C	100%
	0°C	85%
	-15°C	65%
Self-discharge (25°C)	3 month	Remaining Capacity: 91%
	6 month	Remaining Capacity: 82%
	12 month	Remaining Capacity: 65%
Nominal operating temperature		25°C ± 3°C (77°F ± 5°F)
Operating temperature range	Discharge	-15°C ~ 50°C (5°F ~ 122°F)
	Charge	-10°C ~ 50°C (14°F ~ 122°F)
	Storage	-20°C ~ 50°C (-4°F ~ 122°F)
Float charging voltage(25°C)		2.25 to 2.30V Temperature compensation: -3mV/°C
Cyclic charging voltage(25°C)		2.42 to 2.48V Temperature compensation: -5mV/°C
Maximum charging current		120A
Terminal material		Copper
Maximum discharge current		4000A(5 sec.)
Designed floating life(20°C)		20 years

- ◆ Absorbent glass mat technology;
- ◆ Recognized by UL & CE;
- ◆ ABS container.

Constant Current Discharge Characteristics (A, 25°C)

F.V/TIME	15min	30min	60min	2h	3h	4h	5h	6h	8h	10h	20h	24h
1.60V	810	540	360	219	156	125	109	93.6	73.4	61.1	32.1	27.8
1.65V	791	529	355	218	155	125	108	93.1	73.0	61.0	32.0	27.7
1.70V	761	513	346	216	154	124	108	92.4	72.5	60.8	31.9	27.7
1.75V	735	501	339	213	153	123	107	91.8	72.0	60.4	31.7	27.5
1.80V	697	482	328	207	148	119	104	89.0	69.8	60.0	31.5	27.3

Constant Power Discharge Characteristics (Watt, 25°C)

F.V/TIME	15min	30min	60min	2h	3h	4h	5h	6h	8h	10h	20h	24h
1.60V	1482	1010	684	423	306	246	215	184	146	122	64.1	55.9
1.65V	1447	990	674	421	304	244	213	183	145	121	64.0	55.8
1.70V	1393	959	657	417	302	243	212	182	144	121	63.8	55.6
1.75V	1346	936	644	411	300	241	210	181	143	120	63.4	55.3
1.80V	1275	902	624	400	291	234	204	175	139	119	63.0	54.9

Note: The above characteristics data can be obtained within three charge/discharge cycles.

Dimensions

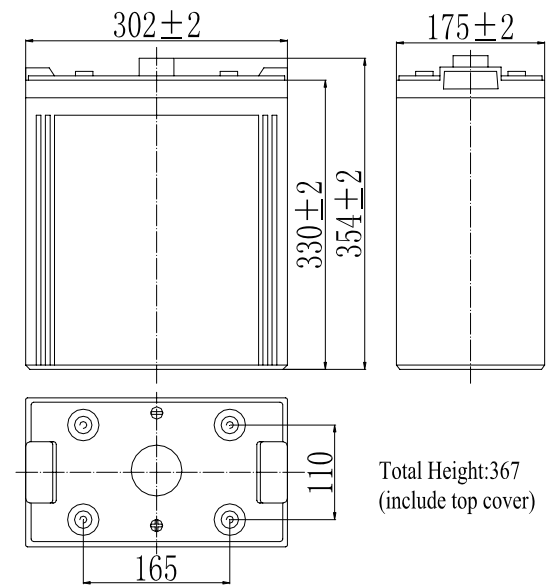

Terminal

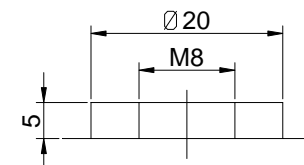

Terminal T10

Discharge Characteristics(25°C)

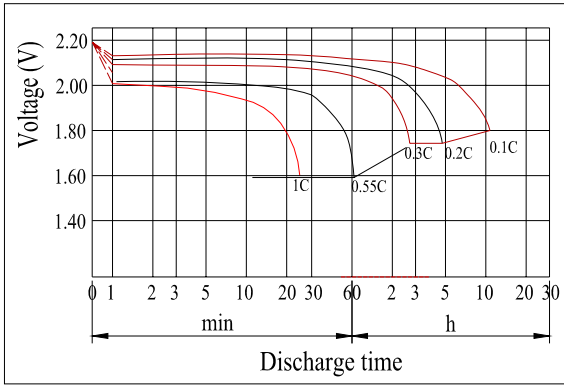

Charging Characteristics(25°C)

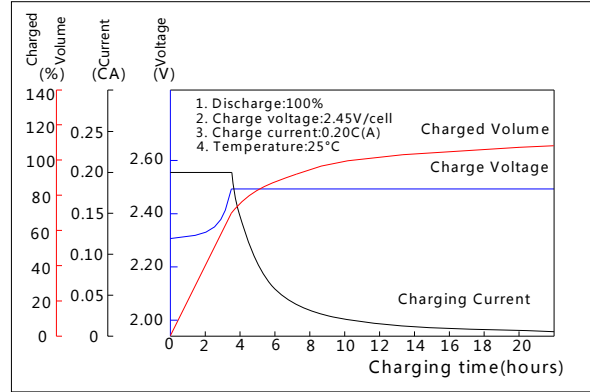

Effect of Temperature on Capacity

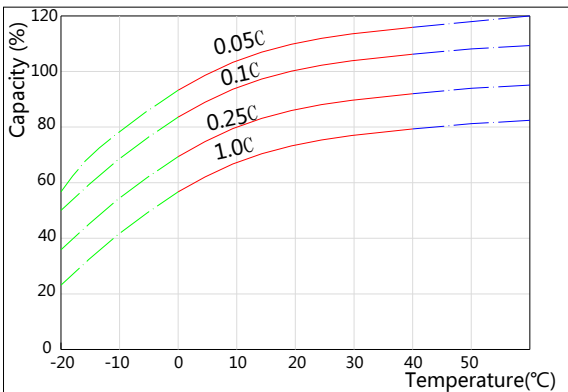

Self-discharge Characteristics

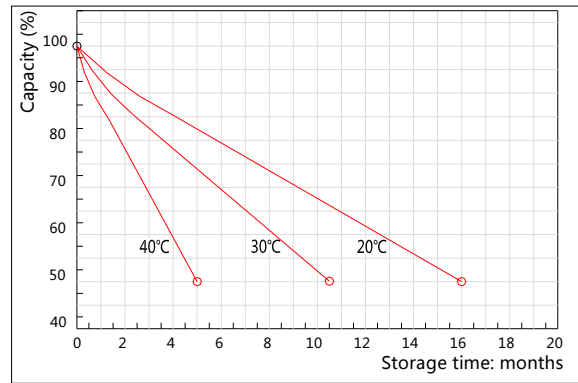

The Relationship for Open Circuit Voltage and Residual Capacity (25°C)

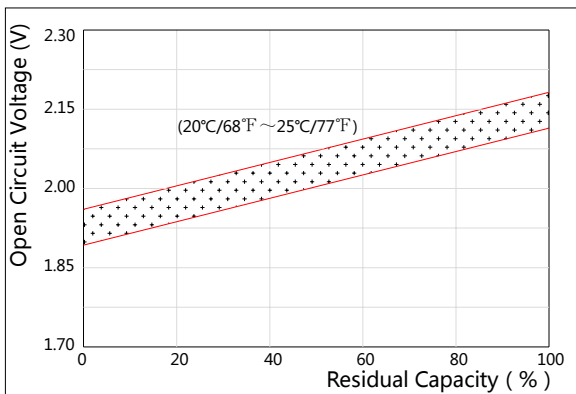

The Relationship for Charging Voltage and Temperature

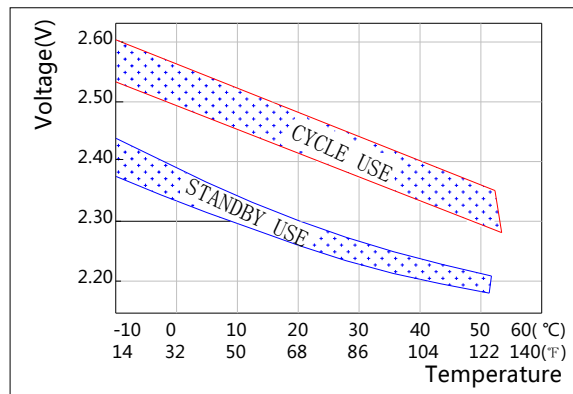

Floating Life on Temperature

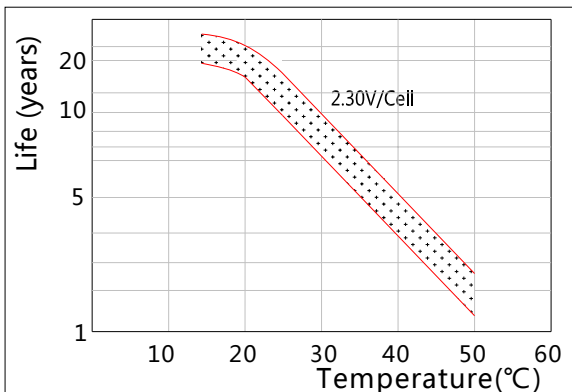

Cycle Life on D.O.D(25°C)

