

**Specifications**

Nominal Voltage		12 V
Capacity (25°C)	10HR(10.8V)	150 Ah
	5HR(10.5V)	130Ah
	1HR(9.60V)	93Ah
Dimension	Length	494 ± 2mm (19.45inch)
	Width	206 ± 2mm (8.11inch)
	Height	209 ± 2mm (8.23inch)
	Total Height	235 ± 2mm (9.25inch)
Approx. Weight		47kg (103bs) ± 4%
Terminal type		T20/T11
Internal resistance (Fully charged, 25°C)		Approx. 3.8m Ω
Capacity affected by temperature (10HR)	40°C	102%
	25°C	100%
	0°C	85%
	-15°C	65%
Self-discharge (25°C)	3 month	Remaining Capacity: 91%
	6 month	Remaining Capacity: 82%
	12 month	Remaining Capacity: 65%
Nominal operating temperature		25°C ± 3°C (77°F ± 5°F)
Operating temperature range	Discharge	-15°C ~ 50°C (5°F ~ 122°F)
	Charge	-10°C ~ 50°C (14°F ~ 122°F)
	Storage	-20°C ~ 50°C (-4°F ~ 122°F)
Float charging voltage(25°C)		13.50 to 13.80V Temperature compensation: -18mV/°C
Cyclic charging voltage(25°C)		14.50 to 14.90V Temperature compensation: -30mV/°C
Maximum charging current		45A
Terminal material		T20: Lead, T11: Copper
Maximum discharge current		1200A(5 sec.)
Designed floating life(20°C)		12 years

**Dimensions**

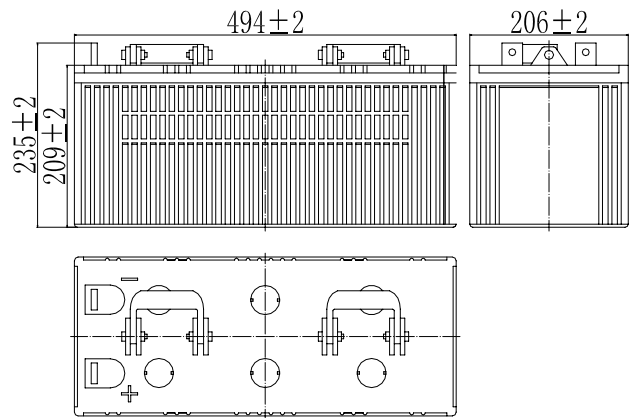

**Terminal**

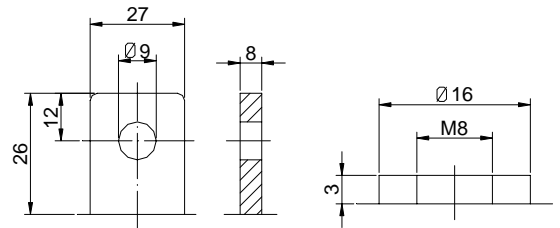

Terminal T20

Terminal T11

- ◆ Absorbent glass mat technology;
- ◆ Recognized by UL & CE;
- ◆ ABS container.

**Constant Current Discharge Characteristics (A, 25°C)**

F.V/TIME	15min	30min	60min	2h	3h	4h	5h	6h	8h	10h	20h
9.60V	248	150	93.0	54.8	38.3	31.4	26.8	23.4	18.4	15.3	8.02
9.90V	242	147	91.6	54.5	38.0	31.2	26.6	23.3	18.3	15.2	8.00
10.2V	233	143	89.3	54.0	37.8	31.0	26.4	23.1	18.1	15.2	7.98
10.5V	225	139	87.5	53.2	37.5	30.8	26.3	23.0	18.0	15.1	7.93
10.8V	213	134	84.8	51.8	36.4	29.8	25.5	22.3	17.5	15.0	7.88

**Constant Power Discharge Characteristics (Watt, 25°C)**

F.V/TIME	15min	30min	60min	2h	3h	4h	5h	6h	8h	10h	20h
9.60V	2718	1683	1060	635	450	369	316	277	218	182	96.2
9.90V	2652	1649	1044	631	447	367	315	275	217	182	96.0
10.2V	2554	1599	1018	625	444	364	312	273	215	181	95.7
10.5V	2468	1560	998	616	441	362	310	271	214	180	95.2
10.8V	2337	1503	967	600	428	351	301	263	207	179	94.5

Note: The above characteristics data can be obtained within three charge/discharge cycles.

**Discharge Characteristics(25°C)**

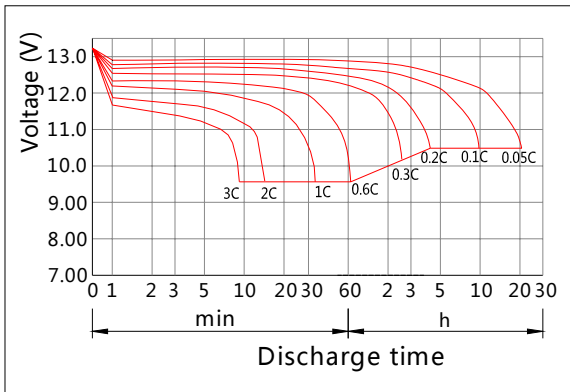

**Charging Characteristics(25°C)**

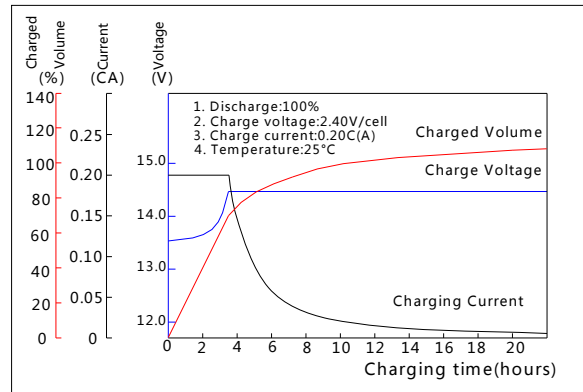

**Effect of Temperature on Capacity**

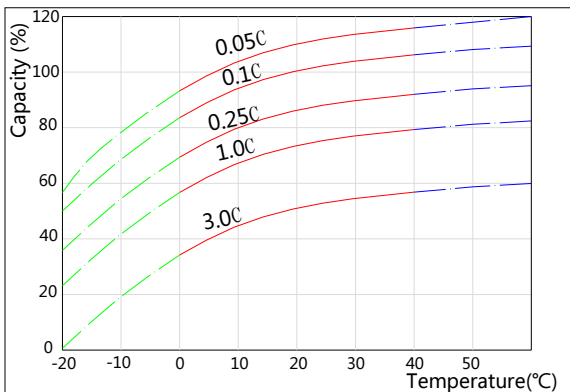

**Self-discharge Characteristics**

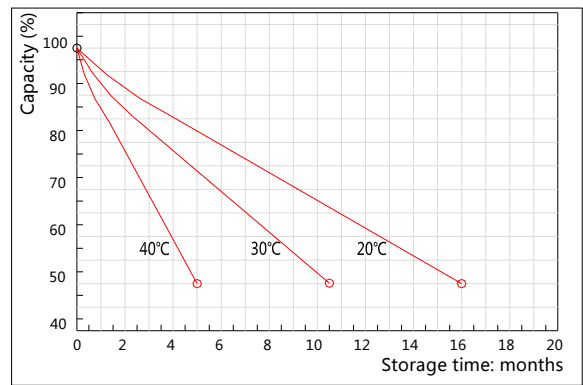

**The Relationship for Open Circuit Voltage and Residual Capacity (25°C)**

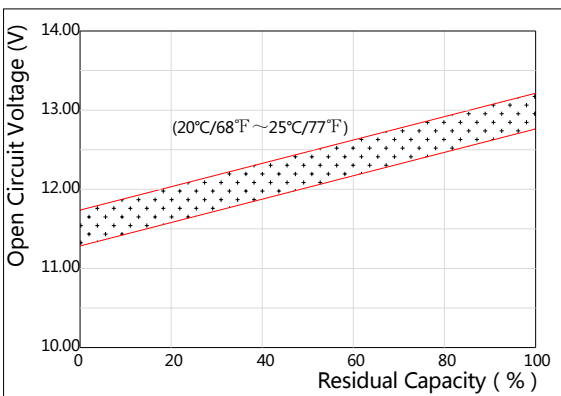

**The Relationship for Charging Voltage and Temperature**

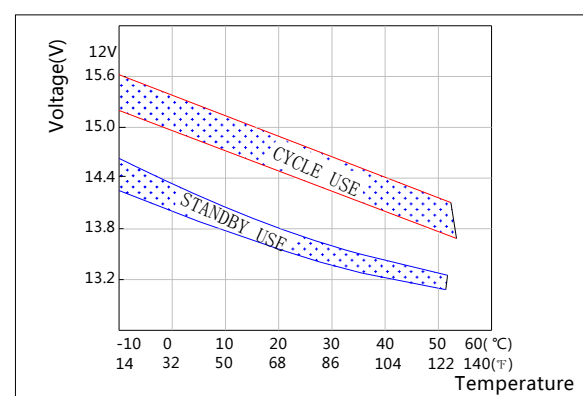

**Floating Life on Temperature**

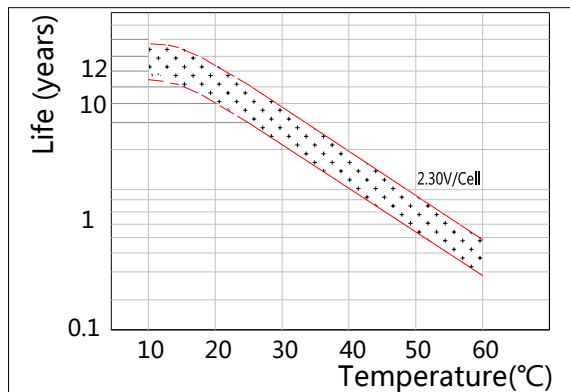

**Cycle Life on D.O.D(25°C)**

