

Specifications

Nominal Voltage		12 V
Capacity (25°C)	10HR(10.8V)	250 Ah
	5HR(10.5V)	219Ah
	1HR(9.60V)	155Ah
Dimension	Length	521 ± 2mm (20.51inch)
	Width	269 ± 2mm (10.59inch)
	Height	220 ± 2mm (8.66inch)
	Total Height	T5: 242 ± 2mm (9.53inch) T11: 223 ± 2mm (8.78inch)
Approx. Weight		72.8kg (160 lbs)± 3%
Terminal type		T5/T11
Internal resistance (Fully charged, 25°C)		Approx. 2.6m Ω
Capacity affected by temperature (10HR)	40°C	102%
	25°C	100%
	0°C	85%
	-15°C	65%
Self-discharge (25°C)	3 month	Remaining Capacity: 91%
	6 month	Remaining Capacity: 82%
	12 month	Remaining Capacity: 65%
Nominal operating temperature		25°C ± 3°C (77°F ± 5°F)
Operating temperature range	Discharge	-15°C ~ 50°C (5°F ~ 122°F)
	Charge	-10°C ~ 50°C (14°F ~ 122°F)
	Storage	-20°C ~ 50°C (-4°F ~ 122°F)
Float charging voltage(25°C)		13.50 to 13.80V Temperature compensation: -18mV/°C
Cyclic charging voltage(25°C)		14.50 to 14.90V Temperature compensation: -30mV/°C
Maximum charging current		75A
Terminal material		Copper
Maximum discharge current		1800A(5 sec.)
Designed floating life(20°C)		12 years

- ◆ Absorbent glass mat technology;
- ◆ Recognized by UL & CE;
- ◆ ABS container.

Constant Current Discharge Characteristics (A, 25°C)

F.V/TIME	15min	30min	60min	2h	3h	4h	5h	6h	8h	10h	20h
9.60V	413	250	155	91.4	63.8	52.3	44.6	39.0	30.6	25.5	13.4
9.90V	403	245	153	90.8	63.4	52.0	44.4	38.8	30.4	25.4	13.3
10.2V	388	238	149	90.0	62.9	51.6	44.1	38.5	30.2	25.3	13.3
10.5V	375	232	146	88.7	62.5	51.3	43.8	38.3	30.0	25.2	13.2
10.8V	355	223	141	86.4	60.6	49.7	42.4	37.1	29.1	25.0	13.1

Constant Power Discharge Characteristics (Watt, 25°C)

F.V/TIME	15min	30min	60min	2h	3h	4h	5h	6h	8h	10h	20h
9.60V	4529	2805	1767	1058	750	615	527	461	364	304	160
9.90V	4421	2749	1740	1052	745	611	524	458	361	303	160
10.2V	4257	2665	1696	1042	740	607	521	455	359	302	160
10.5V	4113	2600	1663	1027	735	603	517	452	356	301	159
10.8V	3895	2505	1612	1001	713	585	502	439	346	299	158

Note: The above characteristics data can be obtained within three charge/discharge cycles.



Dimensions

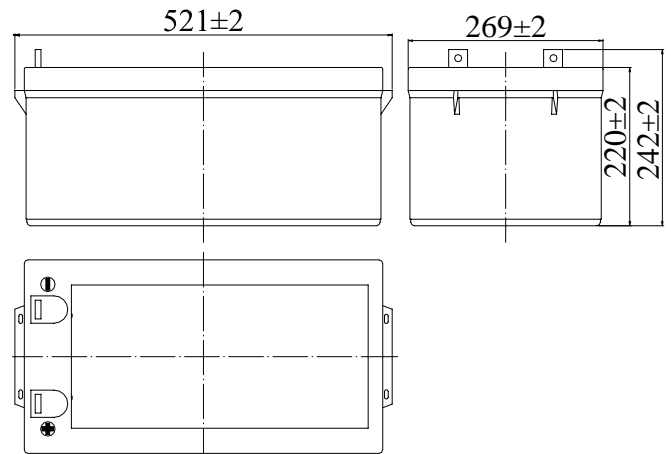

Terminal

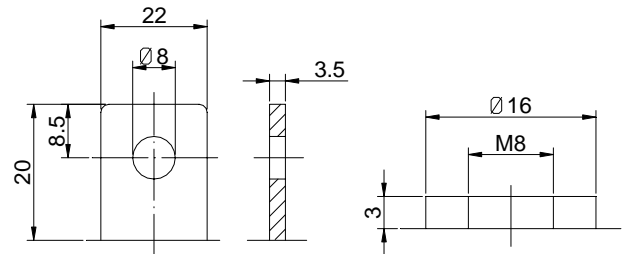

Terminal T5

Terminal T11

Discharge Characteristics(25°C)

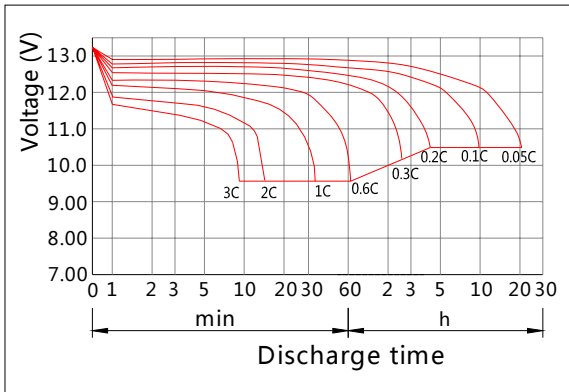

Charging Characteristics(25°C)

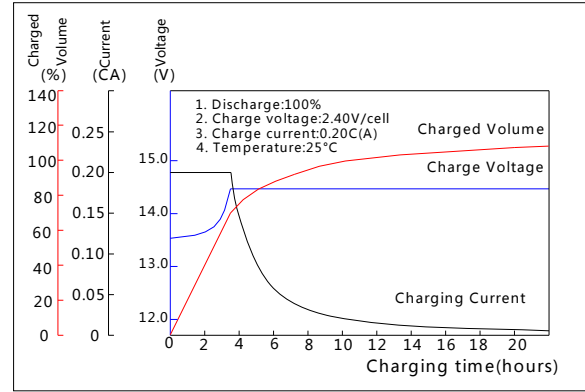

Effect of Temperature on Capacity

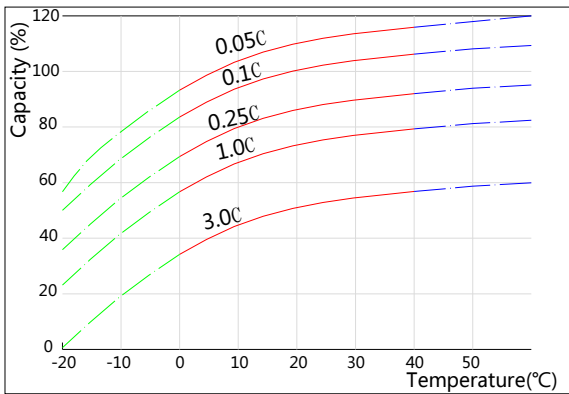

Self-discharge Characteristics

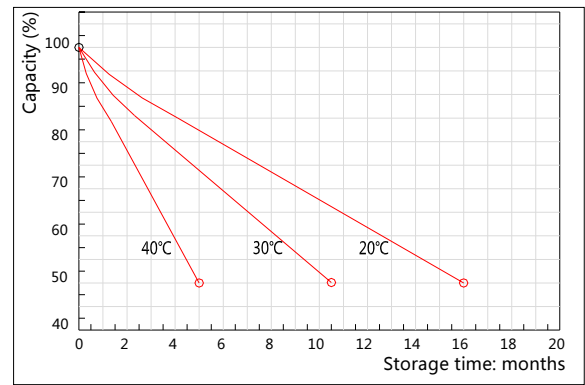

The Relationship for Open Circuit Voltage and Residual Capacity (25°C)

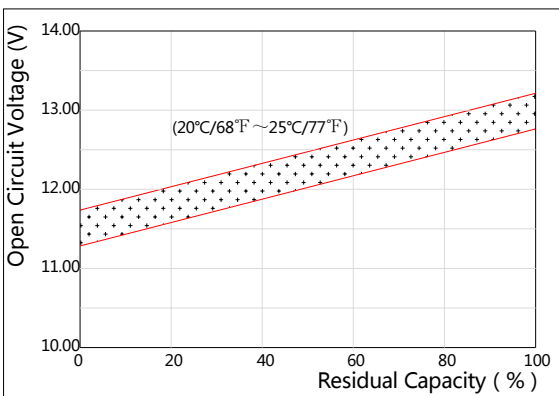

The Relationship for Charging Voltage and Temperature

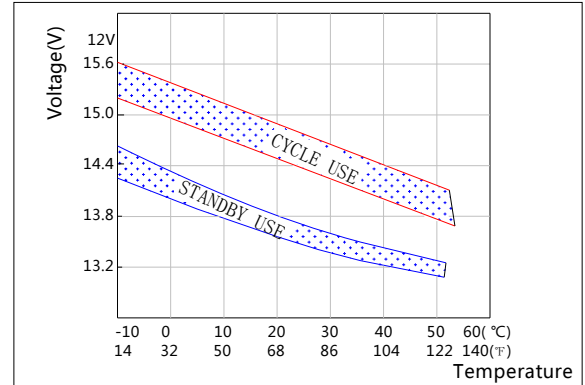

Floating Life on Temperature

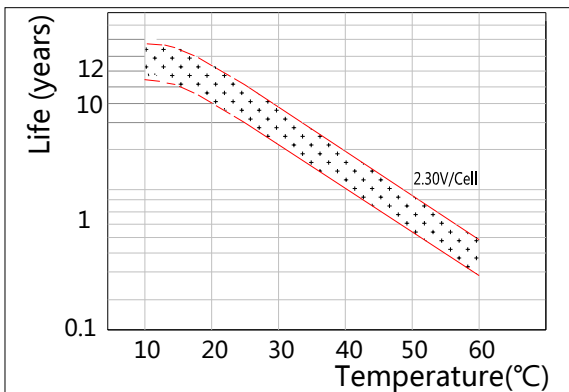

Cycle Life on D.O.D(25°C)

