

Specifications

Nominal Voltage		12 V
Capacity (25°C)	10HR(10.8V)	45 Ah
	5HR(10.5V)	39.4Ah
	1HR(9.60V)	27.9Ah
Dimension	Length	197±2mm (7.76inch)
	Width	165±2mm (6.50inch)
	Height	175±2mm (6.89inch)
	Total Height	T6: 182±2mm (7.17inch) T9: 175±2mm (6.89inch)
Approx. Weight		14kg (30.9lbs)±4%
Terminal type		T6/T9
Internal resistance (Fully charged, 25°C)		Approx. 8mΩ
Capacity affected by temperature (10HR)	40°C	102%
	25°C	100%
	0°C	85%
	-15°C	65%
Self-discharge (25°C)	3 month	Remaining Capacity: 91%
	6 month	Remaining Capacity: 82%
	12 month	Remaining Capacity: 65%
Nominal operating temperature		25°C±3°C(77°F±5°F)
Operating temperature range	Discharge	-15°C~50°C(5°F~122°F)
	Charge	-10°C~50°C(14°F~122°F)
	Storage	-20°C~50°C(-4°F~122°F)
Float charging voltage(25°C)		13.50 to 13.80V Temperature compensation: -18mV/°C
Cyclic charging voltage(25°C)		14.50 to 14.90V Temperature compensation: -30mV/°C
Maximum charging current		13.5A
Terminal material		T6: Lead, T9: Copper
Maximum discharge current		450A(5 sec.)
Designed floating life(20°C)		12 years

- ◆ Absorbent glass mat technology;
- ◆ Recognized by UL & CE;
- ◆ ABS container.

Constant Current Discharge Characteristics (A, 25°C)

F.V/TIME	10min	15min	30min	60min	2h	3h	4h	5h	8h	10h	20h
9.60V	94.5	74.3	45.0	27.9	16.4	11.5	9.41	8.03	5.51	4.58	2.41
9.90V	91.7	72.5	44.1	27.5	16.3	11.4	9.35	7.99	5.48	4.57	2.40
10.2V	87.9	69.8	42.8	26.8	16.2	11.3	9.29	7.93	5.44	4.56	2.39
10.5V	84.1	67.4	41.7	26.3	16.0	11.3	9.23	7.88	5.40	4.53	2.38
10.8V	79.4	63.9	40.2	25.4	15.6	10.9	8.95	7.64	5.24	4.50	2.36

Constant Power Discharge Characteristics (Watt, 25°C)

F.V/TIME	10min	15min	30min	60min	2h	3h	4h	5h	8h	10h	20h
9.60V	1021	815	505	318	190	135	111	94.9	65.4	54.7	28.9
9.90V	990	796	495	313	189	134	110	94.4	65.1	54.6	28.8
10.2V	949	766	480	305	188	133	109	93.7	64.6	54.4	28.7
10.5V	908	740	468	299	185	132	108	93.1	64.2	54.1	28.5
10.8V	857	701	451	290	180	128	105	90.3	62.2	53.7	28.4

Note: The above characteristics data can be obtained within three charge/discharge cycles.

Dimensions

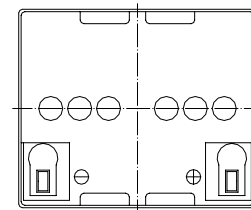
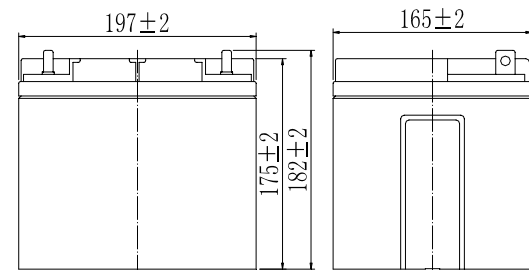

Terminal

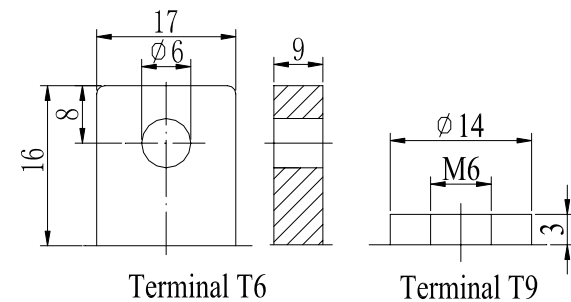

Discharge Characteristics(25°C)

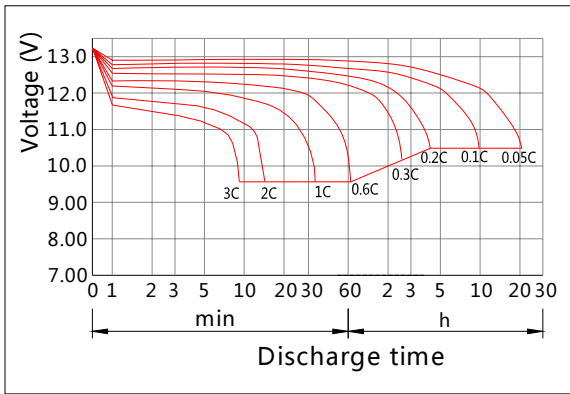

Charging Characteristics(25°C)

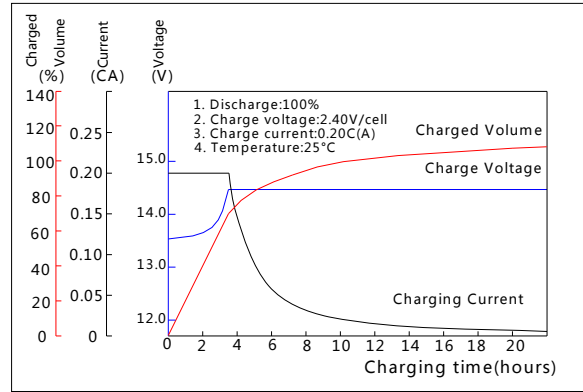

Effect of Temperature on Capacity

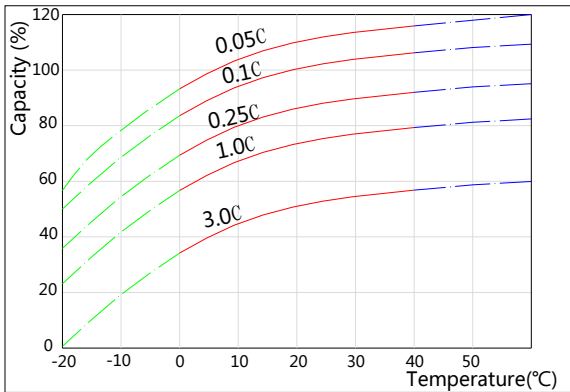

Self-discharge Characteristics

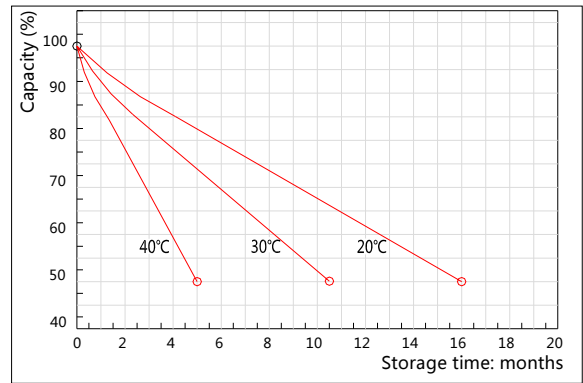

The Relationship for Open Circuit Voltage and Residual Capacity (25°C)

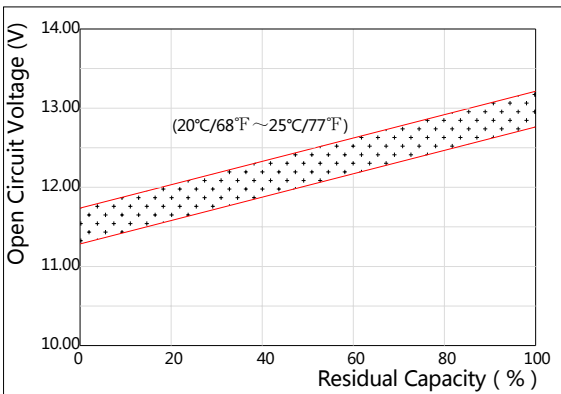

The Relationship for Charging Voltage and Temperature

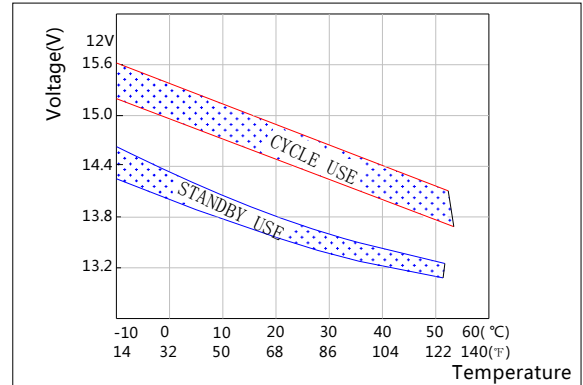

Floating Life on Temperature

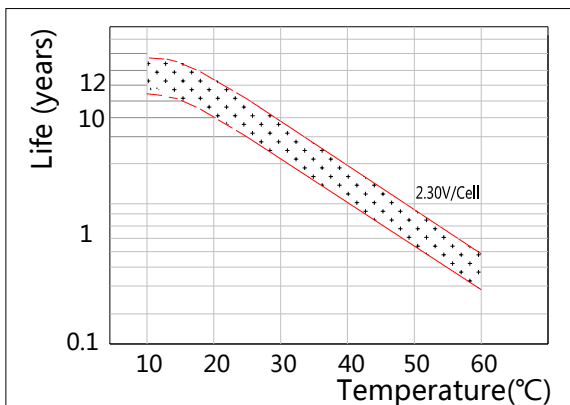

Cycle Life on D.O.D(25°C)

